

Seamless Weld Fittings

Specifications

Wingrou stocks Butt Weld fittings made from high quality carbon alloy steel to ASTM A234 which can be used in various piping systems. The advantages of Butt Weld include:

- Welding a fitting to the pipe means that it is permanently leak proof.
- The continuous metal structure formed between the pipe and fitting adds strength to the system.
- Smoother inner surface and gradual direction changed reduce the pressure losses and turbulence and minimises the action of corrosion and abrasion.
- A welded system utilises minimal space.

Butt Weld Fittings Specifications Standard Weight

Dimensional Tolerance

Buttweld STD ASTM A234 WPB ANSI B16.9 Dimensional Tolerance							
ALL FITTINGS				90° & 45° ELBOWS	TEES	REDUCERS	CAPS
NOMINAL PIPE SIZE (NPS)	OUTSIDE DIAMETER AT BEVEL	INSIDE DIAMETER AT END	WALL THICKNESS	CENTRE TO END	CENTRE TO END	OVERALL LENGTH	OVERALL LENGTH
1/2" – 2 1/2"	+1.5MM -0.7MM	+0.8MM -0.8MM	NOT LESS THAN 87.50% OF NOMINAL WALL THICKNESS	+2.0MM -2.0MM	+2.0MM -2.0MM	+2.0MM -2.0MM	+3.0MM – 3.0MM
3" – 4"	+1.5MM -1.5MM	+1.5MM -1.5MM					
5" – 8"	+2.2MM -1.5MM						
10" – 12"	+4.0MM -3.0MM	+3.2MM -3.2MM					
20" – 24"	+6.4MM -4.8MM	+4.8MM -4.8MM					+6.3MM -6.3MM

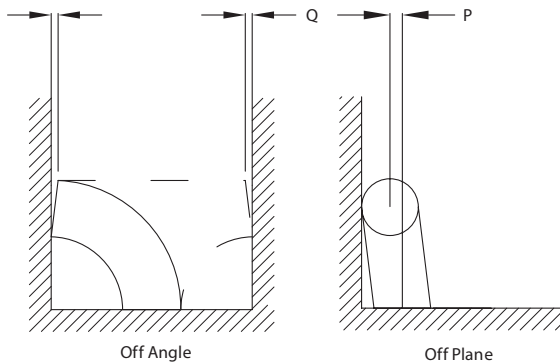

ANGULARITY		
NOMINAL PIPE SIZE (NPS)	OFF ANGLE (Q)	OFF PLANE (P)
1/2" – 2 1/2"	1.0MM	2.0MM
3" – 3 1/2"	2.0MM	4.0MM
4"	3.0MM	5.0MM
5" – 8"		6.0MM
10" – 18"	4.0MM	10.0MM
20" – 24"	5.0MM	

Butt Weld Fittings Specifications Light Weight

Dimensional Tolerance

SGP JIS B 2311 Dimensional Tolerance						
ALL FITTINGS				90° & 45° ELBOWS	TEES	REDUCERS
NOMINAL PIPE SIZE (NPS)	OUTSIDE DIAMETER AT BEVEL	INSIDE DIAMETER AT END	WALL THICKNESS	CENTRE TO END	CENTRE TO END	OVERALL LENGTH
2" – 2 1/2"	+2.0MM -2.0MM	+2.0MM -2.0MM	+NOT SPECIFIED -15.00%	+2.0MM -2.0MM	+2.0MM -2.0MM	+2.0MM -2.0MM
3" – 4"	+2.5MM -2.5MM	+2.5MM -2.5MM				
5" – 8"	+3.5MM -3.5MM	+3.5MM -3.5MM				

Welding End Preparation Selection

Butt Weld STD ASTM A234 ANSI B16.9 Welding End Preparation To ANSI B16.25	
WALL THICKNESS	WELDING END PREPARATION
LESS THAN T (*)	CUT SQUARE OR SLIGHTLY CHAMFERED AT MANUFACTURER'S OPTION.
T (*) TO 22 INCLUDED	PLAIN BEVEL AS SKETCH (A)
MORE THAN 22	COMPOUND BEVEL AS SKETCH (B)
NOTE :- (*)	T = 5MM FOR CARBON, FERRITIC ALLOY STEEL OR WROUGHT IRON;
	T = 4MM FOR AUSTENITIC ALLOY STEEL

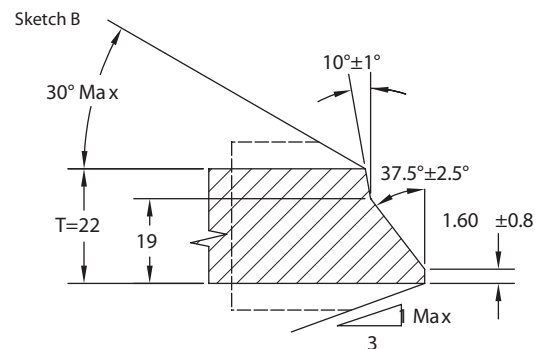
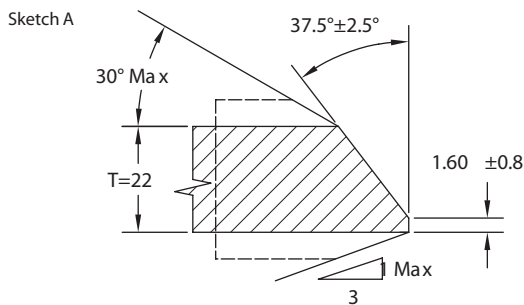

BUTT WELD FITTINGS

Material Specifications

Pressure / Temperature Ratings											
Seamless Carbon Steel Pipe Grade B											
NOMINAL SIZE DN MM	TEMP C			-29 TO 38	205	260	350	370	400	430	450
	WALL THICKNESS			MAXIMUM ALLOWABLE PRESSURE / TEMPERATURE RATINGS IN KPA (TO ANSI/ASME B31.3A)							
		SCHED NO.	MM								
15	STD	40	2.77	34416	34416	32528	29255	28910	22372	18589	14972
	XS	80	3.73	48092	48092	45446	40878	40396	31260	25969	20918
20	STD	40	2.87	28070	28070	26526	23860	23578	18245	15158	12209
	XS	80	3.91	39418	39418	37247	33506	33106	25617	21283	17142
25	STD	40	3.38	26251	26251	24804	22310	22048	17060	14173	11417
	XS	80	4.55	36283	36283	34285	38040	30474	23584	19595	15785
32	STD	40	3.56	21614	21614	20421	18369	18155	14049	11672	9404
	XS	80	4.85	30178	30178	28518	25651	25348	19616	16295	13125
40	STD	40	3.68	19444	19444	18375	16529	16329	12636	10500	8454
	XS	80	5.08	27404	27402	25900	23295	23019	17811	14800	11919
50	STD	40	3.91	16378	16378	15468	13925	13759	10645	8847	7124
	XS	80	5.54	23653	23653	22351	20105	19871	15378	12774	10287
65	STD	40	5.16	17914	17914	16929	15227	15048	11644	9674	7793
	XS	80	7.01	24818	24818	23447	21097	20849	16129	13401	10797
80	STD	40	5.49	15558	15558	14696	13222	13063	10108	8399	6766
	XS	80	7.62	21986	21986	20780	18693	18472	14290	11871	9563
100	STD	40	6.02	13187	13187	12464	11210	11079	8571	7124	5739
	XS	80	8.56	19058	19058	18010	16198	16012	12388	12094	8289
125	STD	40	6.55	11561	11561	10921	9825	9708	7517	6243	5038
	XS	80	9.53	17060	17060	16122	14503	14331	11093	9212	7421
150	STD	40	7.11	10500	10500	9928	8924	8819	6828	5670	4568
	XS	80	10.97	16474	16474	15571	14007	13842	10707	8895	7165
200	STD	40	8.18	9246	9246	8737	7855	7765	6008	4995	4024
	XS	80	12.7	14572	14572	13766	12388	12237	9474	7868	6338
250	STD	40	9.27	8385	8385	7923	7131	7048	5450	4527	3652
	XS		12.7	11595	11595	10955	9853	9736	7538	6263	5043
300	STD	60	9.53	7241	7241	6842	6153	6084	4706	3914	3149
	XS		12.7	9722	9722	9191	8268	8165	6318	5250	4230
350	STD	30	9.53	6580	6580	6222	5595	5533	4279	3555	2866
	XS		12.7	8833	8833	8351	7510	7421	5739	4768	3845
400	STD	30	9.53	5746	5746	5429	4885	4830	3734	3100	2501
	XS	40	12.7	7703	7703	7283	6545	6470	5009	4162	3349
450	STD		9.53	5099	5099	4816	4334	4286	3314	2756	2219
	XS		12.7	6835	6835	6456	5808	5739	4437	3686	2969
500	STD	20	9.53	4582	4582	4327	3893	3852	2976	2474	1991
	XS	30	12.7	6139	6139	5801	5216	5154	3989	3314	2666
600	STD	20	9.53	3810	3810	3603	3238	3197	2474	2060	1660
	XS		12.7	5097	5097	4816	4334	4286	3314	2756	2219

Butt Weld Long Radius Elbow 90 Degree Lightweight

Long Radius Elbow 90 Degree LIGHTWEIGHT JIS B 2311

CODE	NB	A	B	C	WALL THICKNESS	APPROX KG/PC
BWEL025	25	33.5	30.3	38.1	3.2	0.15
BWEL032	32	42.2	38.7	47.8	3.5	0.25
BWEL040	40	48.3	44.8	57.2	3.5	0.35
BWEL050	50	60.5	52.9	76.2	3.8	0.61
BWEL065	65	76.3	67.9	95.3	4.2	1.08
BWEL080	80	89.1	80.7	114.3	4.2	1.66
BWEL100	100	114.3	105.3	152.4	4.5	2.87
BWEL125	125	139.8	130.8	190.5	4.5	4.31
BWEL150	150	165.2	155.2	228.6	5.0	6.57
BWEL200	200	216.3	204.7	304.8	5.8	13.47

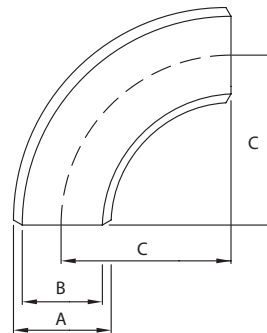

Butt Weld Short Radius Elbow 90 Degree Lightweight

Short Radius Elbow 90 Degree LIGHTWEIGHT JIS B 2311

CODE	NB	A	B	C	WALL THICKNESS	APPROX KG/PC
BWES90L065	65	76.3	67.9	63.5	4.2	0.8
BWES90L080	80	89.1	80.7	76.2	4.2	1.1
BWES90L100	100	114.3	105.3	101.6	4.5	1.9
BWES90L200	200	216.3	204.7	203.2	5.8	9.8

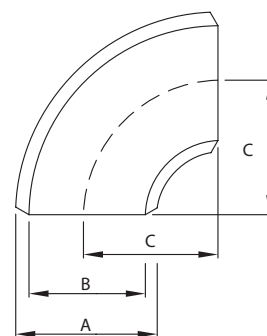

BUTT WELD FITTINGS

Butt Weld Long Radius Elbow 45 Degree Lightweight

Long Radius Elbow 45 Degree LIGHTWEIGHT JIS B 2311

CODE	NB	A	B	C	WALL THICKNESS	APPROX KG/PC
BWE45L050	50	60.5	52.9	31.6	3.8	0.3
BWE45L065	65	76.3	67.9	69.5	4.2	0.5
BWE45L080	80	89.1	80.7	47.3	4.2	0.7
BWE45L100	100	114.3	105.3	63.1	4.5	1.3
BWE45L125	125	139.8	130.8	78.9	4.5	2.0
BWE45L150	150	165.2	155.2	94.7	5.0	3.4

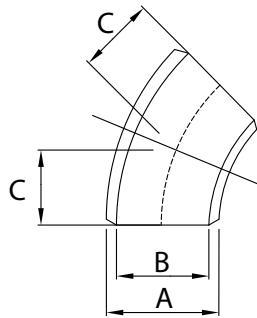

Butt Weld Concentric Reducer Lightweight

Concentric Reducer LIGHTWEIGHT JIS B 2311								
CODE	NB	LARGER DIAMETER		SMALLER DIAMETER		END TO END	WALL THICKNESS	APPROX KG/PC
		A1	A2	B1	B2	C		
BWRCL065050	65 x 50	76.3	67.9	60.5	52.9	88.9	4.2	0.59
BWRCL080050	80 x 50	89.1	80.7	60.5	52.9	88.9	4.2	0.66
BWRCL080065	80 x 65	89.1	80.7	76.3	67.9	88.9	4.2	0.73
BWRCL100050	100 x 50	114.3	105.3	60.5	52.9	101.6	4.5	0.97
BWRCL100065	100 x 65	114.3	105.3	76.3	67.9	101.6	4.5	1.04
BWRCL100080	100 x 80	114.3	105.3	89.1	80.7	101.6	4.5	1.10
BWRCL125065	125 x 65	139.8	130.8	76.3	67.9	127.0	4.5	1.50
BWRCL125080	125 x 80	139.8	130.8	89.1	80.7	127.0	4.5	1.58
BWRCL125100	125 x 100	139.8	130.8	114.3	105.3	127.0	4.5	1.74
BWRCL150065	150 x 65	165.2	155.2	76.3	67.9	139.7	5.0	2.09
BWRCL150100	150 x 100	165.2	155.2	114.3	105.3	139.7	5.0	2.36
BWRCL150125	150 x 125	165.2	155.2	139.8	130.8	139.7	5.0	2.55
BWRCL200100	200 x 100	216.3	204.7	114.3	105.3	152.4	5.8	3.67
BWRCL200125	200 x 125	216.3	204.7	139.8	130.8	152.4	5.8	3.87
BWRCL200150	200 x 150	216.3	204.7	165.2	155.2	152.4	5.8	4.17
BWRCL250150	250 x 150	267.4	254.2	165.2	155.2	177.8	5.0	6.32
BWRCL250200	250 x 200	267.4	254.2	216.3	204.7	177.8	6.6	6.87
BWRCL300200	300 x 200	318.5	304.7	216.3	204.7	203.2	6.9	9.29
BWRCL300250	300 x 250	318.5	304.7	267.4	254.2	203.2	6.9	9.97

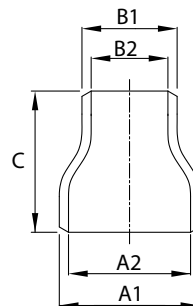

Butt Weld Equal Tee Lightweight

Equal Tee LIGHTWEIGHT JIS B 2311						
CODE	NB	A	B	C	WALL THICKNESS	APPROX KG/PC
BWTL065	65	76.3	67.9	76.2	4.2	1.7
BWTL080	80	89.1	80.7	85.7	4.2	2.0
BWTL100	100	114.3	105.3	104.8	4.5	3.4
BWTL150	150	165.2	155.2	142.9	5	11.4
BWTL200	200	219.1	204.7	177.8	5.8	17.9
BWTL250	250	267.4	254.2	215.9	6.6	21.8

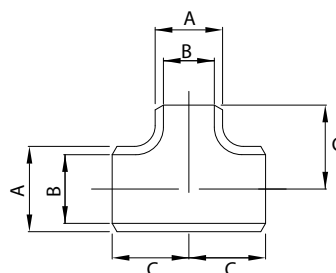

BUTT WELD FITTINGS

Butt Weld Long Radius Elbow 90 Degree STD

Long Radius Elbow 90 Degree STD ASTM A234 WPB ANSI B16.9						
CODE	NB	A	B	C	WALL THICKNESS	APPROX KG/PC
BWE90015	15	21.3	15.8	38.1	2.8	0.07
BWE90020	20	26.7	20.9	38.1	2.9	0.08
BWE90025	25	33.5	26.6	38.1	3.4	0.18
BWE90032	32	42.2	35.1	47.8	3.6	0.25
BWE90040	40	48.3	40.9	57.2	3.7	0.36
BWE90050	50	60.2	52.6	76.2	3.9	0.73
BWE90065	65	73.2	62.7	95.3	5.2	1.45
BWE90080	80	88.9	78.0	114.3	5.5	2.18
BWE90090	90	101.6	90.2	133.4	5.7	3.00
BWE90100	100	114.3	102.4	152.4	6.0	4.05
BWE90125	125	141.2	128.3	190.5	6.6	6.86
BWE90150	150	168.4	154.2	228.6	7.1	10.91
BWE90200	200	219.2	202.7	304.8	8.2	21.73
BWE90250	250	273.1	254.5	381.0	9.3	37.91
BWE90300	300	323.9	304.8	457.2	9.5	55.91
BWE90350	350	355.6	336.6	533.4	9.5	70.45
BWE90400	400	406.4	387.4	609.6	9.5	93.64
BWE90450	450	457.2	438.2	685.8	9.5	119.09
BWE90500	500	508.0	489.0	762.0	9.5	147.27
BWE90600	600	609.6	590.6	914.4	9.5	211.82

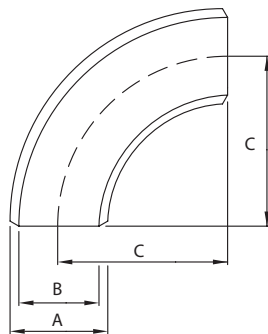

Butt Weld Short Radius Elbow 90 Degree STD

Short Radius Elbow 90 Degree STD ASTM A234 WPB ANSI B16.9						
CODE	NB	A	B	C	WALL THICKNESS	APPROX KG/PC
BWES90020	20	26.6	20.86	-	2.87	0.07
BWES90025	25	33.5	26.7	25.4	3.4	0.11
BWES90032	32	42.2	35.1	31.8	3.6	0.18
BWES90040	40	48.3	40.9	38.1	3.7	0.24
BWES90050	50	60.5	52.6	50.8	3.9	0.44
BWES90065	65	73.2	62.7	63.5	5.2	0.91
BWES90080	80	88.9	78.0	76.2	5.5	1.36
BWES90090	90	101.6	90.2	88.9	5.7	1.95
BWES90100	100	114.3	102.4	101.6	6.0	2.77
BWES90125	125	141.2	128.3	127.0	6.6	4.41
BWES90150	150	168.4	154.2	152.4	7.1	7.59
BWES90200	200	219.2	202.7	203.2	8.2	14.73
BWES90250	250	273.1	254.5	254.0	9.3	25.59
BWES90300	300	323.9	304.8	304.8	9.5	36.09

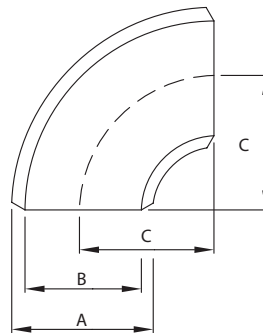

BUTT WELD FITTINGS

Butt Weld Long Radius Elbow 45 Degree STD

Long Radius Elbow 45 Degree STD ASTM A234 WPB ANSI B16.9						
CODE	NB	A	B	C	WALL THICKNESS	APPROX KG/PC
BWE45015	15	21.3	15.8	15.7	2.8	0.04
BWE45020	20	26.7	20.9	19.1	2.9	0.05
BWE45025	25	33.5	26.7	22.4	3.4	0.10
BWE45032	32	42.2	35.1	25.4	3.6	0.15
BWE45040	40	48.3	40.9	28.4	3.7	0.20
BWE45050	50	60.5	52.6	35.1	3.9	0.39
BWE45065	65	73.2	62.7	44.5	5.2	0.77
BWE45080	80	88.9	78.0	50.8	5.5	1.14
BWE45100	100	114.3	102.4	63.5	6.0	2.05
BWE45125	125	141.2	128.3	79.2	6.6	3.41
BWE45150	150	168.1	153.9	95.3	7.1	5.32
BWE45200	200	218.9	202.7	127.0	8.2	10.59
BWE45250	250	273.1	254.5	158.8	9.3	18.59
BWE45300	300	323.9	304.8	190.5	9.5	27.91
BWE45350	350	355.6	336.6	222.3	9.5	35.50
BWE45400	400	406.4	387.4	254.0	9.5	45.91

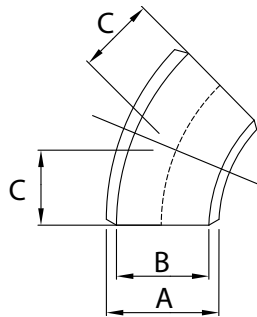

Butt Weld Concentric Reducer STD

Concentric Reducer STD ASTM A234 WPB ANSI B16.9								
CODE	NB	LARGER DIAMETER		SMALLER DIAMETER		END TO END	WALL THICKNESS	APPROX KG/PC
		A1	A2	B1	B2	C		
BWRC020015	20 x 15	26.7	20.9	21.3	15.8	38.1	2.9	0.06
BWRC025015	25 x 15	33.4	26.6	21.3	15.8	50.8	3.4	0.11
BWRC025020	25 x 20	33.4	26.6	26.7	20.9	50.8	3.4	0.12
BWRC032015	32 x 15	42.2	35.1	21.3	15.8	50.8	3.6	0.13
BWRC032020	32 x 20	42.2	35.1	26.7	20.9	50.8	3.6	0.14
BWRC032025	32 x 25	42.2	35.1	33.4	26.6	50.8	3.6	0.16
BWRC040015	40 x 15	48.3	40.9	21.3	15.7	63.5	3.7	0.20
BWRC040020	40 x 20	48.3	40.9	26.7	20.9	63.5	3.7	0.20
BWRC040025	40 x 25	48.3	40.9	33.4	26.6	63.5	3.7	0.22
BWRC040032	40 x 32	48.3	40.9	42.2	35.1	63.5	3.7	0.24
BWRC050015	50 x 15	60.3	52.5	21.3	15.8	76.2	3.9	0.30
BWRC050020	50 x 20	60.3	52.5	26.7	20.9	76.2	3.9	0.30
BWRC050025	50 x 25	60.3	52.5	33.4	26.6	76.2	3.9	0.32
BWRC050032	50 x 32	60.3	52.5	42.2	35.1	76.2	3.9	0.35
BWRC050040	50 x 40	60.3	52.5	48.3	40.6	76.2	3.9	0.37
BWRC065025	65 x 25	73.0	62.7	33.4	26.6	88.9	5.2	0.59
BWRC065032	65 x 32	73.0	62.7	42.2	35.1	88.9	5.2	0.63
BWRC065040	65 x 40	73.0	62.7	48.3	40.9	88.9	5.2	0.66
BWRC065050	65 x 50	73.0	62.7	60.3	52.5	88.9	5.2	0.72
BWRC080025	80 x 25	88.9	78.7	33.4	26.6	88.9	5.5	0.73
BWRC080032	80 x 32	88.9	77.9	42.2	35.1	88.9	5.5	0.75
BWRC080040	80 x 40	88.9	77.9	48.3	40.9	88.9	5.5	0.78
BWRC080050	80 x 50	88.9	77.9	60.3	52.5	88.9	5.5	0.85
BWRC080065	80 x 65	88.9	77.9	73.0	62.7	88.9	5.5	0.93
BWRC100040	100 x 40	114.3	101.6	48.3	40.9	101.6	6.0	0.00
BWRC100050	100 x 50	114.3	101.6	60.3	52.5	101.6	6.0	1.27
BWRC100065	100 x 65	114.3	102.3	73.0	62.7	101.6	6.0	1.37
BWRC100080	100 x 80	114.3	102.3	88.9	77.9	101.6	6.0	1.45
BWRC125065	125 x 65	141.3	128.2	73.0	62.7	127.0	6.6	2.16
BWRC125080	125 x 80	141.3	128.2	88.9	77.9	127.0	6.6	2.27
BWRC125100	125 x 100	141.3	128.2	114.3	102.3	127.0	6.6	2.50
BWRC150050	150 x 50	168.3	154.1	60.3	52.5	139.7	7.1	2.92
BWRC150065	150 x 65	168.3	154.1	73.0	62.7	139.7	7.1	2.92
BWRC150080	150 x 80	168.3	154.1	88.9	77.9	139.7	7.1	3.04
BWRC150100	150 x 100	168.3	154.1	114.3	102.3	139.7	7.1	3.30
BWRC150125	150 x 125	168.3	154.1	141.3	128.2	139.7	7.1	3.57

BUTT WELD FITTINGS

Butt Weld Concentric Reducer STD (cont)

Concentric Reducer STD ASTM A234 WPB ANSI B16.9								
CODE	NB	LARGER DIAMETER		SMALLER DIAMETER		END TO END	WALL THICKNESS	APPROX KG/PC
		A1	A2	B1	B2	C		
BWRC200080	200 x 80	219.1	202.7	88.9	77.9	152.4	8.2	5.10
BWRC200100	200 x 100	219.1	202.7	114.3	102.3	152.4	8.2	5.10
BWRC200125	200 x 125	219.1	202.7	141.3	128.2	152.4	8.2	5.40
BWRC200150	200 x 150	219.1	202.7	168.3	154.1	152.4	8.2	5.71
BWRC250100	250 x 100	273.1	254.5	114.3	102.3	177.8	9.3	8.06
BWRC250150	250 x 150	273.1	254.5	168.3	154.1	177.8	9.3	8.78
BWRC250200	250 x 200	273.1	254.5	219.1	202.7	177.8	9.3	9.58
BWRC300150	300 x 150	323.9	304.8	168.3	154.1	203.2	9.5	11.80
BWRC300200	300 x 200	323.9	304.8	219.1	202.7	203.2	9.5	12.70
BWRC300250	300 x 250	323.9	304.8	273.1	254.5	203.2	9.5	13.60
BWRC350200	350 x 200	355.6	336.6	219.1	202.7	330.2	9.5	21.80
BWRC350250	350 x 250	355.6	336.6	273.1	254.5	330.2	9.5	23.60
BWRC350300	350 x 300	355.6	336.6	323.9	304.8	330.2	9.5	25.40
BWRC400200	400 x 200	406.4	387.4	219.1	202.7	355.6	9.5	27.80
BWRC400250	400 x 250	406.4	387.4	273.1	254.5	355.6	9.5	27.80
BWRC400300	400 x 300	406.4	387.4	323.9	304.8	355.6	9.5	29.60
BWRC400350	400 x 350	406.4	387.4	355.6	336.6	355.6	9.5	31.00
BWRC450250	450 x 250	457.2	438.2	273.1	254.5	381.0	9.5	34.30
BWRC450300	450 x 300	457.2	438.2	323.9	304.8	381.0	9.5	34.30
BWRC450350	450 x 350	457.2	438.2	355.6	336.6	381.0	9.5	35.70
BWRC450400	450 x 400	457.2	438.2	406.4	387.4	381.0	9.5	37.80

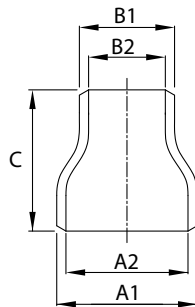

Butt Weld Eccentric Reducer STD

Eccentric Reducer STD ASTM A234 WPB ANSI B16.9								
CODE	NB	LARGER DIAMETER		SMALLER DIAMETER		END TO END	WALL THICKNESS	APPROX KG/PC
		A1	A2	B1	B2	C		
BWRE020015	20 x 15	26.7	20.9	21.3	15.7	38.1	2.8	0.05
BWRE025015	25 x 15	33.7	25.9	21.3	15.7	50.8	3.4	0.10
BWRE025020	25 x 20	33.7	25.9	26.7	20.9	50.8	3.4	0.10
BWRE032015	32 x 15	42.2	35.0	21.3	15.7	50.8	3.6	0.13
BWRE032020	32 x 20	42.2	35.0	26.7	20.9	50.8	3.6	0.14
BWRE032025	32 x 25	42.2	35.0	33.7	25.9	50.8	3.6	0.20
BWRE040015	40 x 15	48.3	40.9	21.3	15.7	63.5	3.7	0.30
BWRE040020	40 x 20	48.3	40.9	26.7	20.9	63.5	3.7	0.20
BWRE040025	40 x 25	48.3	40.9	33.7	25.9	63.5	3.7	0.22
BWRE040032	40 x 32	48.3	40.9	42.2	35.0	63.5	3.7	0.24
BWRE050020	50 x 20	60.3	52.5	26.7	20.9	76.2	3.9	0.30
BWRE050025	50 x 25	60.3	52.5	33.7	25.9	76.2	3.9	0.32
BWRE050032	50 x 32	60.3	52.5	42.2	35.0	76.2	3.9	0.35
BWRE050040	50 x 40	60.3	52.5	48.3	40.9	76.2	3.9	0.72
BWRE065025	65 x 25	73.0	62.6	33.7	25.9	88.9	5.2	0.59
BWRE065032	65 x 32	73.0	62.6	42.2	35.0	88.9	5.2	0.63
BWRE065040	65 x 40	73.0	62.6	48.3	40.9	88.9	5.2	0.66
BWRE065050	65 x 50	73.0	62.6	60.3	52.5	88.9	5.2	0.72
BWRE080025	80 x 25	88.9	77.9	33.7	25.9	88.9	5.5	0.75
BWRE080032	80 x 32	88.9	77.9	42.2	35.0	88.9	5.5	0.75
BWRE080040	80 x 40	88.9	77.9	48.3	40.9	88.9	5.5	0.78
BWRE080050	80 x 50	88.9	77.9	60.3	52.5	88.9	5.5	0.85
BWRE080065	80 x 65	88.9	77.9	73.0	62.6	88.9	5.5	0.93
BWRE100040	100 x 40	114.3	102.3	48.3	40.9	101.6	6.1	1.27
BWRE100050	100 x 50	114.3	102.3	60.3	52.5	101.6	6.1	1.27
BWRE100065	100 x 65	114.3	102.3	73.0	62.6	101.6	6.1	1.37
BWRE100080	100 x 80	114.3	102.3	88.9	77.9	101.6	6.1	1.45
BWRE125080	125 x 80	141.3	128.1	88.9	77.9	127.0	6.6	2.27
BWRE125100	125 x 100	141.3	128.1	114.3	102.3	127.0	6.6	2.50
BWRE150080	150 x 80	168.3	154.1	88.9	77.9	139.7	7.1	3.04
BWRE150100	150 x 100	168.3	154.1	114.3	102.3	139.7	7.1	3.30
BWRE150125	150 x 125	168.3	154.1	141.3	128.1	139.7	7.1	3.57

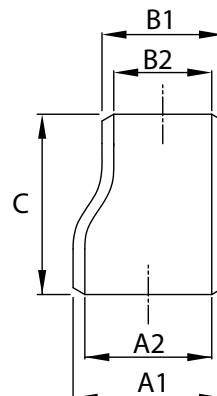

BUTT WELD FITTINGS

Butt Weld Eccentric Reducer STD (cont)

Eccentric Reducer STD ASTM A234 WPB ANSI B16.9								
CODE	NB	LARGER DIAMETER		SMALLER DIAMETER		END TO END	WALL THICKNESS	APPROX KG/PC
		A1	A2	B1	B2	C		
BWRE200100	200 x 100	219.1	202.7	114.3	102.3	152.4	8.2	5.10
BWRE200125	200 x 125	219.1	202.7	141.3	128.1	152.4	8.2	5.40
BWRE200150	200 x 150	219.1	202.7	168.3	154.1	152.4	8.2	5.71
BWRE250150	250 x 150	273.1	254.5	168.3	154.1	177.8	9.3	8.78
BWRE250200	250 x 200	273.1	254.5	219.1	202.7	177.8	9.3	9.58
BWRE300150	300 x 150	323.9	304.9	168.3	154.1	203.2	9.5	12.80
BWRE300200	300 x 200	323.9	304.9	219.1	202.7	203.2	9.5	13.70
BWRE300250	300 x 250	323.9	304.9	273.1	254.5	203.2	9.5	14.70
BWRE350200	350 x 200	355.6	336.5	219.1	202.7	330.2	9.5	21.80
BWRE350250	350 x 250	355.6	336.5	273.1	254.5	330.2	9.5	23.60
BWRE350300	350 x 300	355.6	336.5	323.9	304.9	330.2	9.5	25.40
BWRE400250	400 x 250	406.4	387.4	273.1	254.5	355.6	9.5	27.80
BWRE400350	400 x 350	406.4	387.4	355.6	336.5	355.6	9.5	31.00

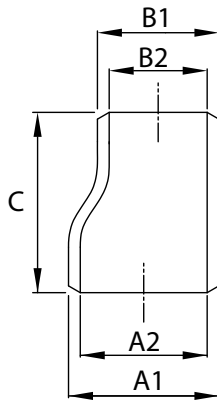

Butt Weld Equal Tee STD

Equal Tee STD ASTM A234 WPB ANSI B16.9						
CODE	NB	A	B	C	WALL THICKNESS	APPROX KG/PC
BWT015	15	22.0	15.7	38.1	2.9	0.10
BWT020	20	26.7	20.9	28.4	2.9	0.17
BWT025	25	33.4	26.6	38.1	3.4	0.35
BWT032	32	42.2	35.0	47.8	3.6	0.58
BWT040	40	48.3	40.9	57.2	3.7	0.76
BWT050	50	60.3	52.5	63.5	3.9	1.14
BWT065	65	73.0	62.6	76.2	5.2	2.03
BWT080	80	88.9	77.9	85.9	5.5	2.94
BWT100	100	114.3	102.3	104.6	6.1	4.67
BWT125	125	141.3	128.1	124.0	6.6	7.48
BWT150	150	168.3	154.1	142.7	7.1	11.35
BWT200	200	219.1	202.7	177.8	8.2	18.21
BWT250	250	273.1	254.5	215.9	9.3	34.71
BWT300	300	323.9	304.9	254.0	9.5	46.82
BWT350	350	355.6	336.5	279.0	9.5	73.00
BWT400	400	406.4	387.3	305.0	9.5	91.00
BWT450	450	457.0	437.9	343.0	9.5	135.00
BWT500	500	508.0	489.0	381.0	9.5	173.00

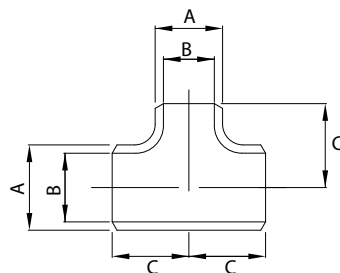

BUTT WELD FITTINGS

Butt Weld Reducing Tee STD

Eccentric Reducer STD ASTM A234 WPB ANSI B16.9

CODE	NB	LARGER DIAMETER		SMALLER DIAMETER		END TO END		WALL THICKNESS	APPROX KG/PC
		A1	A2	B1	B2	C1	C2		
BWTR020015	20 x 15	26.7	20.9	21.3	15.8	28.4	28.4	2.9	0.12
BWTR025015	25 x 15	33.4	26.6	21.3	15.8	38.1	38.1	3.4	0.22
BWTR025020	25 x 20	33.4	26.6	26.7	20.9	38.1	38.1	3.4	0.23
BWTR032015	32 x 15	42.2	35.1	21.3	15.8	47.5	47.5	3.6	0.37
BWTR032020	32 x 20	42.2	35.1	26.7	20.9	47.5	47.5	3.6	0.37
BWTR032025	32 x 25	42.2	35.1	33.4	26.6	47.5	47.5	3.6	0.39
BWTR040015	40 x 15	48.3	40.9	21.3	15.8	57.2	57.2	3.7	0.52
BWTR040020	40 x 20	48.3	40.9	26.7	20.9	57.2	57.2	3.7	0.52
BWTR040025	40 x 25	48.3	40.9	33.4	26.6	57.2	57.2	3.7	0.55
BWTR040032	40 x 32	48.3	40.9	42.2	35.1	57.2	57.2	3.7	0.68
BWTR050020	50 x 20	60.3	52.5	26.7	20.9	63.5	50.8	3.9	0.74
BWTR050025	50 x 25	60.3	52.5	33.4	26.6	63.5	50.8	3.9	0.74
BWTR050032	50 x 32	60.3	52.5	42.2	35.1	63.5	57.2	3.9	0.89
BWTR050040	50 x 40	60.3	52.5	48.3	40.9	63.5	60.2	3.9	0.93
BWTR065025	65 x 25	73.0	62.7	33.4	26.6	76.2	63.5	5.2	1.56
BWTR065032	65 x 32	73.0	62.7	42.2	35.1	76.2	63.5	5.2	1.56
BWTR065040	65 x 40	73.0	62.7	48.3	40.9	76.2	66.5	5.2	1.47
BWTR065050	65 x 50	73.0	62.7	60.3	52.5	76.2	69.9	5.2	1.53
BWTR080025	80 x 25	88.9	77.9	33.4	26.6	85.6	72.9	5.5	2.08
BWTR080032	80 x 32	88.9	77.9	48.3	40.9	85.6	72.9	5.5	2.08
BWTR080040	80 x 40	88.9	77.9	48.3	40.9	85.6	72.9	5.3	2.08
BWTR080050	80 x 50	88.9	77.9	60.3	52.5	96.0	76.2	5.5	2.14
BWTR080065	80 x 65	88.9	77.9	73.0	62.7	96.0	82.6	5.5	2.27
BWTR100040	100 x 40	114.3	102.3	48.3	40.9	104.6	88.9	6.0	3.55
BWTR100050	100 x 50	114.3	102.3	60.3	52.5	104.6	88.9	6.0	3.55
BWTR100065	100 x 65	114.3	102.3	73.0	62.7	104.6	95.3	6.0	3.69
BWTR100080	100 x 80	114.3	102.3	88.9	77.9	104.6	98.3	6.0	3.82
BWTR125080	125 x 80	141.3	128.2	88.9	77.9	123.7	120.7	6.6	8.10
BWTR125100	125 x 100	141.3	128.2	114.3	102.3	123.7	117.3	6.6	6.18
BWTR150065	150 x 65	168.3	154.1	73.0	62.7	142.7	123.7	7.1	8.52
BWTR150080	150 x 80	168.3	154.1	88.9	77.9	142.7	123.7	7.1	8.52
BWTR150100	150 x 100	168.3	154.1	114.3	102.3	142.7	130.0	7.1	8.81
BWTR150125	150 x 125	168.3	154.1	141.3	128.2	142.7	146.1	7.1	9.22

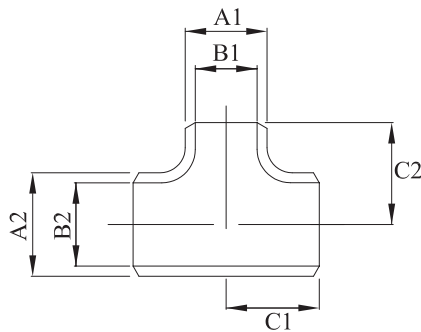

Butt Weld Reducing Tee STD (cont)

Eccentric Reducer STD ASTM A234 WPB ANSI B16.9									
CODE	NB	LARGER DIAMETER		SMALLER DIAMETER		END TO END		WALL THICKNESS	APPROX KG/PC
		A1	A2	B1	B2	C1	C2		
BWTR200080	200 x 80	219.1	202.7	88.9	77.9	177.8	155.4	8.2	18.00
BWTR200100	200 x 100	219.1	202.7	114.3	102.3	177.8	155.4	8.2	18.00
BWTR200125	200 x 125	219.1	202.7	141.3	128.2	177.8	161.8	8.2	18.40
BWTR200150	200 x 150	219.1	202.7	168.3	154.1	177.8	168.1	8.2	18.80
BWTR250100	250 x 100	273.1	254.5	114.3	102.3	215.9	190.5	9.3	30.10
BWTR250125	250 x 125	273.1	254.5	141.3	128.2	215.9	190.5	9.3	30.10
BWTR250150	250 x 150	273.1	254.5	168.3	154.1	215.9	193.5	9.3	30.50
BWTR250200	250 x 200	273.1	254.5	219.1	202.7	215.9	203.2	9.3	32.40
BWTR300150	300 x 150	323.9	304.8	168.3	154.1	254.0	218.9	9.5	51.20
BWTR300200	300 x 200	323.9	304.8	219.1	202.7	254.0	228.6	9.5	53.10
BWTR300250	300 x 250	323.9	304.8	273.1	254.5	254.0	241.3	9.5	55.20

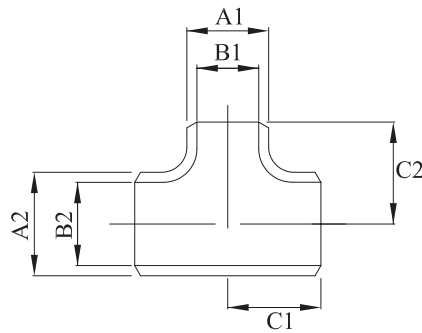

BUTT WELD FITTINGS

Butt Weld Cap STD

Cap STD ASTM A234 WPB ANSI B16.9

CODE	NB	A	B	C	WALL THICKNESS	APPROX KG/PC
BWC025	25	33.4	26.6	38.1	3.4	0.11
BWC032	32	42.2	35.1	38.1	3.6	0.14
BWC040	40	48.3	40.9	38.1	3.7	0.17
BWC050	50	60.3	52.5	38.1	3.9	0.23
BWC065	65	73.0	62.7	38.1	5.2	0.39
BWC080	80	88.9	77.9	50.8	5.5	0.66
BWC100	100	114.3	102.3	63.5	6.0	1.17
BWC125	125	141.3	128.2	76.2	6.6	1.91
BWC150	150	168.3	154.1	88.9	7.1	2.90
BWC200	200	219.1	202.7	101.6	8.2	5.19
BWC250	250	273.1	254.5	127.0	9.3	9.15
BWC300	300	323.9	304.8	152.4	9.5	13.30
BWC350	350	355.6	336.6	165.1	9.5	15.90
BWC400	400	406.4	387.4	177.8	9.5	20.00
BWC450	450	457.2	438.2	203.2	9.5	25.60
BWC500	500	508.0	489.0	228.6	9.5	34.4
BWC600	600	609.6	590.6	267.0	9.5	45.9

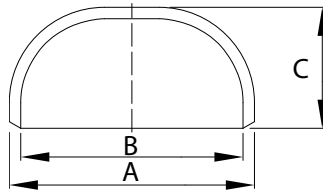

Butt Weld Long Radius Elbow 180 Degree STD

Long Radius Elbow STD ASTM A234 WPB ANSI B16.9							
CODE	NB	A	B	C	D	WALL THICKNESS	APPROX KG/PC
BWE180025	25	33.4	26.6	55.4	76.2	3.4	0.30
BWE180032	32	42.2	35.1	69.9	95.3	3.6	0.51
BWE180040	40	48.3	40.9	82.6	114.3	3.7	0.73
BWE180050	50	60.3	52.5	106.2	152.4	3.9	1.30
BWE180065	65	73.0	62.7	131.6	190.5	5.2	2.58
BWE180080	80	88.9	77.9	158.8	228.6	5.5	4.04
BWE180100	100	114.3	102.3	209.6	304.8	6.0	7.68
BWE180125	125	141.3	128.2	261.9	381.0	6.6	13.00
BWE180150	150	168.3	154.1	312.7	457.2	7.1	20.20
BWE180200	200	219.1	202.7	414.3	609.6	8.2	40.60

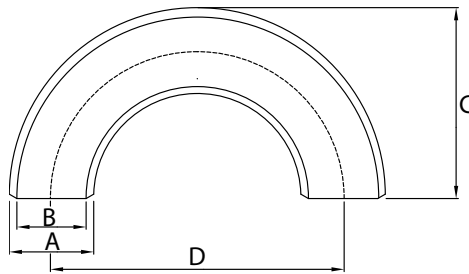

Butt Weld Short Radius Elbow 180 Degree STD

Short Radius Elbow 180 Degree STD ASTM A234 WPB ANSI B16.9							
CODE	NB	A	B	C	D	WALL THICKNESS	APPROX KG/PC
BWES180025	25	33.4	26.6	41.1	50.8	3.4	0.2
BWES180032	32	42.2	35.1	52.3	63.5	3.6	0.34
BWES180040	40	48.3	40.9	61.7	76.2	3.7	0.48
BWES180050	50	60.3	52.5	80.8	101.6	3.9	0.87
BWES180065	65	73.0	62.7	99.8	127.0	5.2	1.72
BWES180080	80	88.9	77.9	120.7	152.4	5.5	2.70
BWES180100	100	114.3	102.3	158.8	203.2	6.0	5.12
BWES180150	150	168.2	154.1	236.5	304.8	7.1	13.5

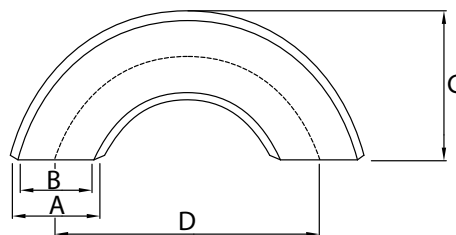

BUTT WELD FITTINGS

Butt Weld Long Radius Elbow 90 Degree XS

Long Radius Elbow 90 Degree XS ASTM A234 WPB ANSI B16.9

CODE	NB	A	B	C	WALL THICKNESS	APPROX KG/PC
BWEX90015	15	21.3	13.8	38.1	3.7	0.10
BWEX90020	20	26.7	18.9	28.4	3.9	0.11
BWEX90025	25	33.4	24.3	38.1	4.6	0.21
BWEX90032	32	42.2	32.5	47.8	4.9	0.39
BWEX90040	40	48.3	38.1	57.2	5.1	0.50
BWEX90050	50	60.3	49.2	76.2	5.5	1.00
BWEX90065	65	73.0	59.0	95.2	7.0	1.82
BWEX90080	80	88.9	73.7	114.3	7.6	2.86
BWEX90100	100	114.3	97.2	152.4	8.6	5.70
BWEX90125	125	139.8	126.6	190.5	6.6	6.48
BWEX90150	150	168.3	146.4	228.6	11.0	16.30
BWEX90200	200	219.1	193.7	304.8	12.7	31.30
BWEX90250	250	273.1	247.7	381.0	12.7	49.40
BWEX90300	300	323.9	298.5	457.2	12.7	71.20

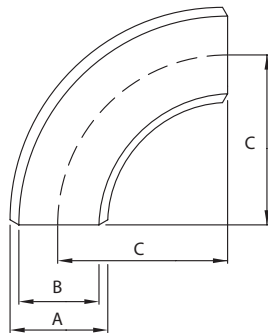

Butt Weld Short Radius Elbow 90 Degree XS

Short Radius Elbow 90 Degree XS ASTM A234 WPB ANSI B16.28

CODE	NB	A	B	C	WALL THICKNESS	APPROX KG/PC
BWESX032	32	42.7	32.9	31.8	4.9	0.34
BWESX040	40	48.3	38.1	38.1	5.1	0.35
BWESX050	50	60.3	49.2	50.8	5.5	0.65
BWESX065	65	73.0	59.0	63.5	7.0	1.45
BWESX080	80	88.9	73.7	76.2	7.6	1.79
BWESX100	100	114.3	97.2	101.6	8.6	3.72
BWESX150	150	168.3	146.4	152.4	11.0	10.35
BWESX200	200	219.1	190.9	203.2	12.7	23.60

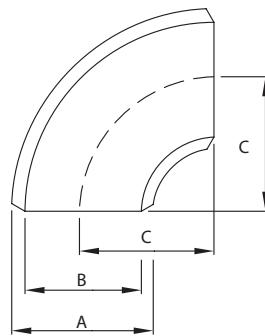

Butt Weld Long Radius Elbow 45 Degree XS

Long Radius Elbow 45 Degree XS ASTM A234 WPB ANSI B16.9

CODE	NB	A	B	C	WALL THICKNESS	APPROX KG/PC
BWE45X015	15	21.7	14.3	15.8	3.7	0.49
BWE45X020	20	26.7	18.9	11.2	3.9	0.06
BWE45X025	25	33.4	24.3	22.4	4.6	0.14
BWE45X032	32	42.2	32.5	25.4	4.9	0.26
BWE45X040	40	48.3	38.1	28.4	5.1	0.29
BWE45X050	50	60.3	49.2	35.1	5.5	0.57
BWE45X065	65	73.0	59.0	44.4	7.0	1.06
BWE45X080	80	88.9	73.7	50.8	7.6	1.43
BWE45X100	100	114.3	97.2	63.5	8.6	2.52
BWE45X150	150	168.3	146.4	95.2	11.0	8.30
BWE45X200	200	219.1	190.9	126.2	12.7	15.30

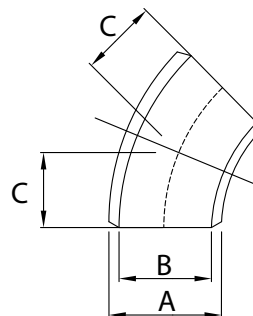

BUTT WELD FITTINGS

Butt Weld Concentric Reducer XS

Concentric Reducer XS ASTM A234 WPB ANSI B16.9

CODE	NB	LARGER DIAMETER		SMALLER DIAMETER		END TO END	WALL THICKNESS	APPROX KG/PC
		A1	A2	B1	B2	C		
BWRCX020015	20 x15	26.7	18.9	21.3	12.2	38.1	3.9	0.08
BWRCX025015	25 x 15	33.4	24.3	21.3	12.2	50.8	4.6	0.18
BWRCX025020	25 x 20	33.4	24.3	26.7	17.6	50.8	4.6	0.18
BWRCX032015	32 x 15	42.2	32.5	21.3	12.2	50.8	4.9	0.18
BWRCX032020	32 x 20	42.2	32.5	26.7	17.0	50.8	4.9	0.23
BWRCX032025	32 x 25	42.2	32.5	33.4	23.7	50.8	4.9	0.23
BWRCX040015	40 x 15	48.3	38.1	21.3	12.2	63.5	5.1	0.27
BWRCX040020	40 x 20	48.3	38.1	26.7	16.5	63.5	5.1	0.32
BWRCX040025	40 x 25	48.3	38.1	33.4	23.2	63.5	5.1	0.32
BWRCX040032	40 x 32	48.3	38.1	42.2	32.0	63.5	5.1	0.32
BWRCX050025	50 x 25	60.3	49.2	33.4	22.3	76.2	5.5	0.54
BWRCX050032	50 x 32	60.3	49.2	42.2	31.1	76.2	5.5	0.54
BWRCX050040	50 x 40	60.3	49.2	48.3	37.2	76.2	5.5	0.54
BWRCX065025	65 x 25	73.0	59.0	33.4	22.3	88.9	7.0	0.76
BWRCX065050	65 x 50	73.0	59.0	60.3	46.3	88.9	7.0	0.91
BWRCX080040	80 x 40	88.9	73.7	48.3	33.1	88.9	7.6	1.27
BWRCX080050	80 x 50	88.9	73.7	60.3	45.1	88.9	7.6	1.27
BWRCX080065	80 x 65	88.9	73.7	73.0	57.8	88.9	7.6	1.27
BWRCX100050	100 x 50	114.3	97.2	60.3	43.2	101.6	8.6	2.18
BWRCX100065	100 x 65	114.3	97.2	73.0	55.9	101.6	8.6	2.18
BWRCX100080	100 x 80	114.3	97.2	88.9	71.8	101.6	8.6	2.18
BWRCX150080	150 x 80	168.3	146.4	88.9	67.0	139.7	11.0	5.40
BWRCX150100	150 x 100	168.3	146.4	114.3	92.4	139.7	11.0	5.40
BWRCX200100	200 x 100	219.1	193.7	114.3	97.2	152.4	12.7	7.68
BWRCX200150	200 x 150	219.1	193.7	168.3	146.3	152.4	12.7	8.63
BWRCX250150	250 x 150	273.1	247.7	168.3	146.3	177.8	12.7	11.80
BWRCX250200	250 x 200	273.1	247.7	219.1	193.7	177.8	12.7	12.90

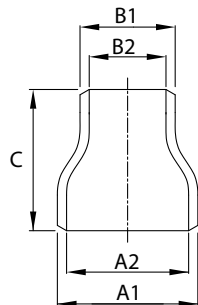

Butt Weld Eccentric Reducer XS

Eccentric Reducer XS ASTM A234 WPB ANSI B16.9								
CODE	NB	LARGER DIAMETER		SMALLER DIAMETER		END TO END	WALL THICKNESS	APPROX KG/PC
		A1	A2	B1	B2	C		
BWREX050040	50 x 40	60.3	49.3	48.3	38.1	76.2	5.5	0.51
BWREX065050	65 x 50	73.0	59.0	60.3	49.3	88.9	7.0	0.92
BWREX080065	80 x 65	88.9	73.7	73.0	59.0	88.9	7.6	1.23
BWREX100065	100 x 65	114.3	97.2	73.0	59.0	101.6	8.6	1.86
BWREX150080	150 x 80	168.3	146.3	88.9	73.7	139.7	11.0	4.56

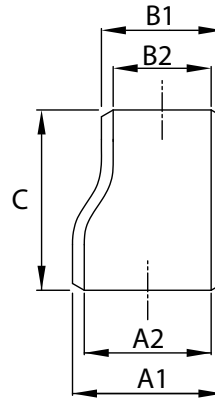

Butt Weld Equal Tee XS

Equal Tee XS ASTM A234 WPB ANSI B16.9						
CODE	NB	A	B	C	WALL THICKNESS	APPROX KG/PC
BWTX015	15	21.3	13.8	38.1	3.7	0.2
BWTX020	20	26.7	18.9	28.4	3.9	0.3
BWTX025	25	33.4	24.3	38.1	4.6	0.4
BWTX032	32	42.2	32.5	47.8	4.9	0.8
BWTX040	40	48.3	38.1	57.2	5.1	1.1
BWTX050	50	60.3	49.2	63.5	5.5	1.7
BWTX065	65	73.0	59.0	76.2	7.0	3.0
BWTX080	80	88.9	73.7	85.9	7.6	4.3
BWTX100	100	114.3	97.2	104.6	8.6	7.3
BWTX150	150	168.3	146.4	142.7	11.0	19.0
BWTX200	200	219.1	193.7	177.8	12.7	30.3

